

ZAPOROZHYE STATE MEDICAL UNIVERSITY

Kaplaushenko A.G., Pryakhin O.R., Varinskiy B.A., Iurchenko I.A.,
Shcherbak M.A., Samelyuk Yu.G., Kucheryavyi Yu.N., Hulina Yu.S.



PHYSICAL AND CHEMICAL PROPERTIES OF DISPERSIVE SYSTEMS

*Teaching and methodical manual
for foreign student*

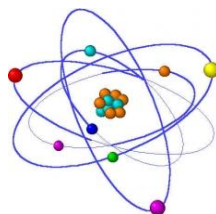

Zaporozhye, 2016

ЗАПОРІЗЬКИЙ ДЕРЖАВНИЙ МЕДИЧНИЙ УНІВЕРСИТЕТ

Каплаушенко А.Г., Пряхін О.Р., Варинський Б.О., Юрченко І.О.,

Щербак М.О., Самелюк Ю.Г., Кучерявий Ю.М., Гуліна Ю.С.

ФІЗИКО-ХІМІЧНІ ВЛАСТИВОСТІ ДИСПЕРСНИХ СИСТЕМ

*Навчально-методичний посібник
для студентів англomовної форми навчання*

Запоріжжя, 2016

UDC 544.7(075.8)=111
BBC 24.6я73
P59

Authors:

Каплаушенко А.Г., Прыахин О.Р., Варинский В.А., Юрченко І.А.,
Щербак М.А., Самелюк Ю.Г., Кучерявий Ю.М., Гуліна Ю.С.

Reviewers:

Parchenko V.V., Dr.hab., Professor of the Department of Toxicology and
Inorganic Chemistry, Zaporozhye State Medical University;

Gladyshev V.V., Dr.hab, Professor, Head of the Department of Medicinal
Preparations Technology, Zaporozhye State Medical University.

Physical and chemical properties of dispersive systems: teaching and
methodical manual for foreign students / A.G. Kaplaushenko, O.R. Pryakhin,
B.A. Varinskiy [et al.]. – 2nd ed., updated and suppl. – Zaporozhye, 2016. – 70
p.

Автори:

Каплаушенко А.Г., Пряхін О.Р., Варинський Б.О., Юрченко І.О.,
Щербак М.О., Самелюк Ю.Г., Кучерявий Ю.М., Гуліна Ю.С.

Рецензенти:

Парченко В.В., професор кафедри токсикологічної та неорганічної хімії
Запорізького державного медичного університету, д. фарм. н.

Гладишев В.В., зав. кафедри технології ліків Запорізького державного
медичного університету, д.фарм.н..

Фізико-хімічні властивості дисперсних систем: навчально-
методичний посібник / А.Г. Каплаушенко, О.Р. Пряхін, Б.О. Варинський
[та ін.]. – 2ге вид., оновл. та доповн. – Запоріжжя, 2016. – 70 с.

Навчальний посібник розглянуто та затверджено:

Цикловою методичною комісією з фармацевтичних дисциплін
(протокол №__ від _____р.),

Центральною методичною радою ЗДМУ
(протокол №__ від _____р.)

CONTENTS

1. Preface.....	5
2. Introduction.....	7
3. Concise theoretical material.....	9
4. Questions for self-training.....	47
5. Tasks.....	50
6. The standard answers.....	52
7. Experimental part.....	55
8. Tests.....	58
9. References.....	65

PREFACE

Medicinal Chemistry is one of the most rapidly developing areas within the discipline of Chemistry, both globally and locally. It is the study of the design, biochemical effects, regulatory and ethical aspects of drugs for the treatment of disease.

The aim of this discipline is to produce graduates with an appropriate background in biology and pharmacology, built upon a strong chemistry foundation.

Methodical recommendation of Medicinal Chemistry is designed to equip students with strong grounding in biological and chemical technique which is relevant to the pharmaceutical world.

The discipline gives an in-depth coverage of the chemical techniques required and relates these to the relevant pharmacology, anatomy, biochemistry and molecular biology.

The whole course of Medical chemistry which consists of ten topics is studied by students-physicians during the first year. Lecturer staff of department has prepared an educational and methodical recommendation in which the theoretical material is stated in the concise and available form.

The distribution of material on each of ten topics that are studied is set according to training program, the thematic plan of lectures and practical training.

The material of each topic is stated in such way that performance of practical work and the solution of situational tasks are preceded by theoretical part in which questions of medicine and biological value and also connection with other disciplines (biological chemistry, normal physiology, pathophysiology and others) are included.

Offered laboratory works and situational tasks will give students the chance to understand theoretical material fully and to use this knowledge in practice.

The experience of teaching medical chemistry shows that it is not always possible to coordinate an order of laboratory works realization with sequence of lecture course statement. That is why students usually have to prepare for practical work performance independently before the lesson. Therefore the theoretical part (in which the necessary volume of knowledge for conscious performance of experiment is given) precedes to each section of these Methodical recommendations.

Increasing of level of seminar and laboratory works is reached by use of such forms of occupations which open and consolidate theoretical knowledge, train scientific thinking, develop creative initiative and impart skills of handling devices and chemicals, chemical ware.

The structures, figures and schemes are clear and easy to follow and color is used well, highlighting main points without being distracting.

Chapters are helpfully signposted throughout, informing the reader how topics are related, which is especially important in such a multidisciplinary subject.

Topics are also presented clearly and with a logical progression culminating in the main points, questions and reading sections at the beginning of each chapter.

An assortment of case studies is provided and the authors work through each one in great detail, giving an overall perspective on the science.

Finally, very useful and informative appendices and a glossary are provided together with a comprehensive index that is good enough to rival any search engine!

There are many books that describe medicinal chemistry and its uses, but these methodological recommendations present medicinal chemistry and its related topics in a clear, informative and interesting way that really demonstrates the application and impact of this fundamental subject in society.

INTRODUCTION

Purpose: To study the basic methods of preparation and purification of sols, the micelle structure, stability and coagulation of sols; thresholding coagulation; electrokinetic phenomena (electrophoresis, electro-osmosis, the flow potential, the potential subsidence) features in the optical properties of sol - Tyndall effect, molecular and kinetic properties of dispersed systems.

Targets:

- learn how to use the hydrolysis reaction, the oxidation-reduction of the double exchange - for reception of sols;
- learn to work on nephelometry - able to record the structure of the micelles lyophobic sol;
- study the effect of ion charge-coagulant on the stability of lyophobic sols - the impact of a mixture of electrolytes on the coagulation action: synergism, antagonism, additivity;
- explore electrokinetic phenomena: electrophoresis, electroosmosis, Dorn effect and Quincke effect.

The student should know :

- equation of chemical reaction obtaining sol, stabilizers ;
- the structure of micelles sol ;
- condensation methods of preparation of sols ;
- air dispersion methods of sol preparation ;
- methods of purification of colloidal solutions ;
- essence nephelometric method of determining the concentration of the sol;
- dependence of the threshold concentration of the charge of the ion - coalescent .
- theoretical foundations of electric charge occurring in the colloidal particles ;
- safety of the instrument for electrophoresis ;
- the reason for the charge occurring of colloidal particles;

- theories describing the occurrence of DES, be able to call electrokinetic phenomena, record the dependence between the electrophoretic velocity and the magnitude of the zeta potential ;
- isoelectric state as a qualitative restructuring of the micelle.

CONCISE THEORETICAL MATERIAL

Colloidal chemistry plays a very important role in biology and medicine, because plants and animals contain complex disperse systems (blood, lymph, plasma, mucus, etc.), while the life processes largely have colloid- chemical character .

Therapeutic agents are various classes of disperse systems: powders, sols, suspensions, emulsions , aerosols, ... Question of resistance and conservation conditions of pharmaceuticals is the paramount for pharmaceutical practice.

Study of disperse systems is necessary for the development of theoretical bases of drug technology . Some processes in the pharmaceutical industry are colloid-chemical processes. For example, the preparation of emulsions, suspensions, creams, ointments reduces to the dispersible substances in the respective environments. Colloidal solutions are advantageously prepared by chemical reaction in controlled conditions.

1. Disperse systems

Colloidal chemistry by the definition of P.A.Rebinder - is part of physical chemistry, in which are considered the processes of formation, destruction and characteristic properties disperse systems. These systems are heterogeneous.

Highly disperse phase is called the phase and the environment in which it is ground, is called a dispersion medium.

All of disperse systems is characterized by two main features :

1. Dispersion, i.e. fragmentation .
2. Heterogeneity, the system consists of two or more phases .

By dispersion systems are divided into three types:

- coarsely dispersed (suspension, emulsion, powder) with particle size 10^{-4} - 10^{-7} m;
- colloidal dispersions (sols) with a particle size 10^{-7} - 10^{-9} m;
- ionic or molecular solutions with particle size less than 10^{-9} m.

Degree of fragmentation of the substance of the dispersed phase is expressed as a dispersion. Dispersibility corresponds to the size of the dispersed particles - the radius (r), the diameter (d) or the inverse of diameter:

$$D=1/d \quad (1)$$

In colloid chemistry the concept of dispersion covers wide but strictly defined area of particle sizes ranging from larger than normal molecules to visible to the naked eye.

The presence of the interface is the main feature of a heterogeneous system.

The main feature of the highly dispersed state due to the small size of the substance particles is extremely large total surface area of the particles of the disperse system that causes some variation in the properties of disperse systems (optical, molecular- kinetic, electrical and surface effects), as compared with the conventional multiphase systems and true solutions.

Specific surface area - is the surface area of dispersed phase particles , which per unit of weight or volume of the dispersed phase:

$$S_{sp}^V = \frac{S}{m} ,$$

$$S_{sp}^V = \frac{S}{V} ,$$

$$S_{sp}^V = \frac{S}{V} = 6D \text{ (for spherical particles).}$$

S_{sp} are used to characterize the degree of fragmentation of the substance.

2. Classification of dispersed systems

Disperse systems are classified according to various criteria: by dispersion, state of aggregation, structure (loosely dispersed or coherently dispersed), interfacial interaction (lyophilic and lyophobic).

Upon dispersion are considered highly dispersed systems (ultramicro- and microheterogeneous with particles size of 1 - 100 nm and 100-10,000 nm) and coarsely dispersed systems with particles sizes of the dispersed phase greater than 1.10 micron.

Ultramicroheterogeneous systems (1-100 nm) are called colloid.

Classification according to the degree of interaction with the dispersed phase dispersion medium.

On interaction with the dispersed phase dispersion medium systems are:

1. Lyophilic system is system, in which the interaction between the particles of dispersed phase with solvent is highly expressed. Thermodynamically stable system. Dispersed phase in such environments may be subject of spontaneous dispersion. Examples of such systems: SAS, solutions of macromolecular substances, some clays, etc.

2 . Lyophobic or hydrophobic. The dispersed phase interacts weakly with the dispersion medium. Systems require special methods of stabilization, as they are thermodynamically unstable. Such systems are metal sols, lyosol, emulsions, aerosols, foams.

According to the classification of aggregation dispersed systems are conventionally designated by two letters, the first of which corresponds to the state of aggregation of the dispersed phase, and the second - aggregation of the dispersion medium.

For example, the notation S / L means that solid is crushed in the liquid medium.

Table 1

Classification of dispersed systems in the aggregate state

Dispersed phase	Dispersion medium	Designation of system	Examples
Gas	Gas	G/G	The earth's atmosphere
Liquid	Gas	L/G	Fog, clouds, aerosols of liquid medicines
Solid	Gas	S/G	Smoke, dust, smog, powders, sprays of

			solid drug
Gas	Liquid	G/L	Foam, gas emulsion
Liquid	Liquid	L/L	Emulsions (milk, medical emulsion)
Solid	Liquid	S/L	Suspensions, lysol
Gas	Solid	G/S	Solid foam, pumice, silica gel
Liquid	Solid	L/S	Pearls, capillary systems, gels
Solid	Solid	S/S	Colored glass, minerals, alloys

3. Methods of preparation of disperse systems

By particle size sols occupy an intermediate position between true solutions and coarse systems.

Therefore, all the methods of preparation of colloidal systems can be divided into two main groups:

1. Dispersing - crushing large particles of coarse to the colloidal systems.
2. Condensation - enlargement of molecules and ions of true solutions in larger aggregates of colloidal size.

Methods of chemical condensation.

Based on conducting chemical reactions in solution, accompanied by the formation of insoluble or poorly soluble substances.

This reaction may be: reduction, oxidation, decomposition, hydrolysis, etc.

Recovery: get metal sols.

Red gold sol - reduction reaction of gold salt (sodium aurate) formaldehyde:

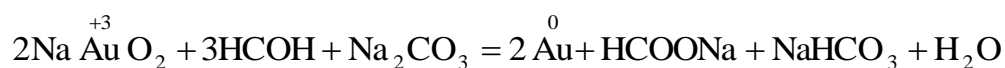

aurate formaldehyde sodium

on the forming particles (microcrystals of gold) adsorb ions AuO_2^- - forming potential ions. Counter-ions - Na^+ .

The structure of the particles can be presented as scheme:

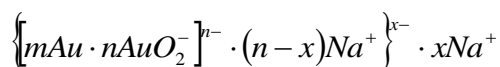

gold particles have a negative charge X-.

The same method can be used for preparation a yellow-brown silver sol from silver nitrate (very dilute solution).

Oxidation: preparation of sulfur and selenium sols by oxygen:

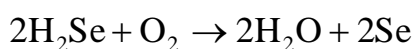
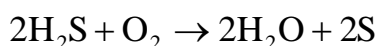

Structure of sulfur sol

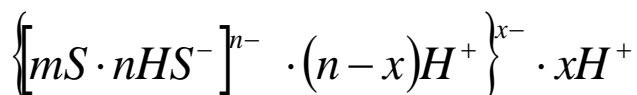

Decompounding: preparation sulfur sol by decomposition of thiosulfate and polysulfates:

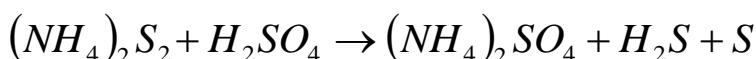

Double exchange: to get many sols of hardly soluble compounds

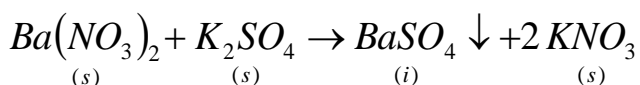
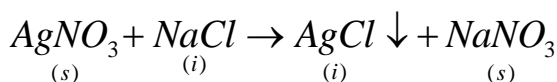

Hydrolysis: to get sols of heavy metal hydroxides:

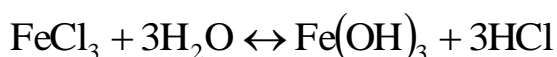

The degree of hydrolysis increases with temperature and dilution increasing.

Circuit of structure of the micelles sol:

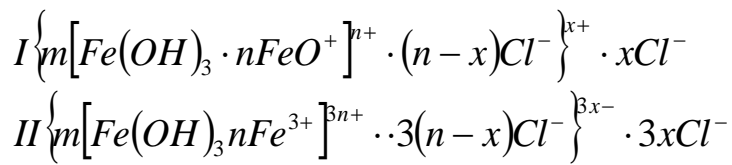

Through hydrolysis may be prepared the sols of silicon, tungsten, titanium or other insoluble acid.

Methods of dispersion.

Dispergating - fine grinding of solids or liquids, and the distribution of their particles in the liquid or gaseous medium.

As a result, are forming powders, suspensions, aerosols, emulsions .

Mechanical dispersion. For producing the colloidal solutions by this method, grinding and crushing solids in special machines - colloid mills are held.

The first colloid mill was designed by Russian engineer Plausson K. (1920) - a hermetically sealed, rapidly rotating mechanism of percussion. Modern colloid mills are shown in the Fig. 1.



Fig. 1. Modern colloil mills

The basis of the action of mills machines are the principles of crushing, cracking, abrasion, impact, etc. - The process is generally carried out in the presence of SAS.

Electric spraying method: through any dispersion medium (e.g. water) electric current is passed between the electrodes made of a material, a colloidal

solution of which want to get - one electrode sprays. Colloidal solutions of gold, silver, platinum, and other metals are obtained.

Ultrasonic pulverizing: ultrasonic waves with a frequency from 20 thousand to 1 million cycles per second is obtained using the piezoelectric oscillator.

The suspension of coarse substance that has been fragmented under the action of ultrasonic waves crush to a colloidal state.

Thus obtain colloidal solutions of resins, gypsum, graphite, metals, dyes, starch, etc.

Although the methods of dispersion are improving, for maximum dispersion of 10^{-7} - 10^{-9} m only condensation methods are suitable (they are also less energy-consuming).

At the same time air dispersion methods have more practical meaning.

Electrohydraulic kick - a new way of obtaining disperse systems, providing a high degree of dispersion with minimal time.

Electrohydraulic technology - the result of fundamental and applied research, development activities and pilot inspections of equipment conducted by the Institute of Pulse Processes and Technologies NAS of Ukraine (Nikolaev) . IPPT NAS - the exclusive organization in the world specializing in the study of the physical and technical aspects of pulse processes and creating impulse technologies .

Peptization method. Transfer of sediment in the sol by treatment with peptizing agents - electrolyte solutions, SAS or solvent. During peptization there is no change in degree of dispersion of the particles.

The result of peptization is dissociation of particles and their distribution throughout the volume of the dispersion medium.

Consider the following example: get gelatinous precipitate of ferric hydroxide:

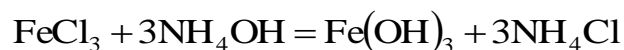

Direct peptization: acting by solution FeCl₃. Iron ions adsorbing on the surface of the particles, reported them a positive charge, like-charged particles repel from each other and move from the sediment into the solution:

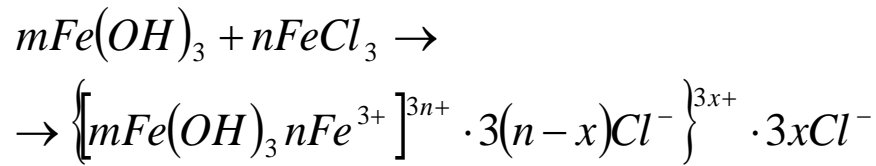

Moderate peptization: acting by dilute hydrochloric acid. Part of the molecules of Fe(OH)₃ reacts with HCl to forming iron oxychloride FeOCl. Ions of newly obtained peptizer FeO⁺ adsorbing on the surface of sediment particles translate it into a colloidal state:

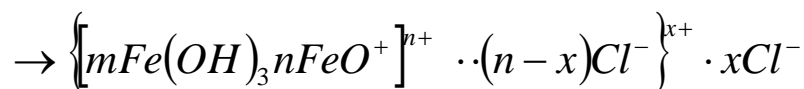
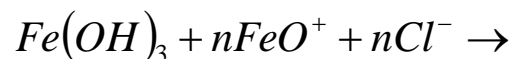
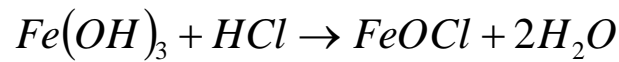

In many cases, the process of peptization is mixed .

Peptization is effected by: the structure of a sediment, the age of a sediment (coagels), peptizer concentration, mechanical stress, temperature.

Freshly precipitated strongly hydrated sediments are resolved more easily. Aging coagels impair the peptization (as aging coagels compacts). The old sediments often lose the ability to peptize. Stirring favors peptization. With increasing temperature the rate of peptization increases.

4. Purification of colloidal solutions.

Colloidal solutions prepared by any method usually contain a number of impurities (raw material or side-products). All these substances change the properties of colloidal systems and therefore should be removed.

Basic cleaning methods of sols.

Dialysis: The process of purification (separation) of colloidal solutions, which is based on the ability of semipermeable membrane to pass the impurity of ions, and molecules of small size and delay colloidal particles.

The device for cleaning colloids is called dialyzer.

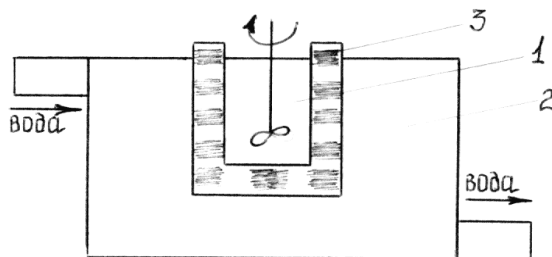

Fig. 2. Dialyzer scheme:

1 - purified solution

2 - solvent (water)

3 - membrane.

Continuously or periodically changing the solvent in the dialyzer the total purification of the colloidal solution is achieved.

A lack of simple dialyzer - long duration of the cleaning process (sometimes weeks, months).

Electrodialysis: dialysis process accelerated by applying an electrical current (the electrodes are introduced into the solvent 4).

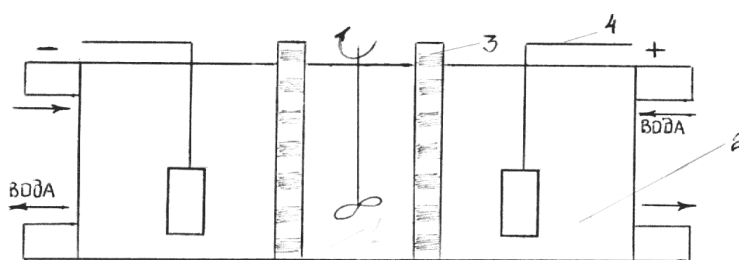

Fig. 3. Scheme of electro-dialysis.

Under the influence of the electric field cations are transferred from the middle compartment to the cathode chamber, anions - to the anode. Even traces of electrolytes are delated that is not achieved by ordinary dialysis.

Cleaning time is reduced significantly (hours, minutes).

Electrodialysis finds industrial application: this method removes salt from the whey. Demineralized whey contains large amounts of lactose and proteins, and is used for dietary products.

Ultrafiltration : Filtration of colloidal solution through a semipermeable membrane under pressure or in vacuum. Colloidal particles remain on the filter (membrane), and the filtrate containing low molecular weight substance passes into the solvent .

To accelerate this process, ultrafiltration is carried out under the pressure (sometimes in vacuum) .

Membranes – are special polymer skins, pore size of which is 10^{-5} - 10^{-6} cm.

The process of ultrafiltration is used for concentrating of sol used by separating the dispersed phase from the dispersion medium and contained therein and low molecular weight substances.

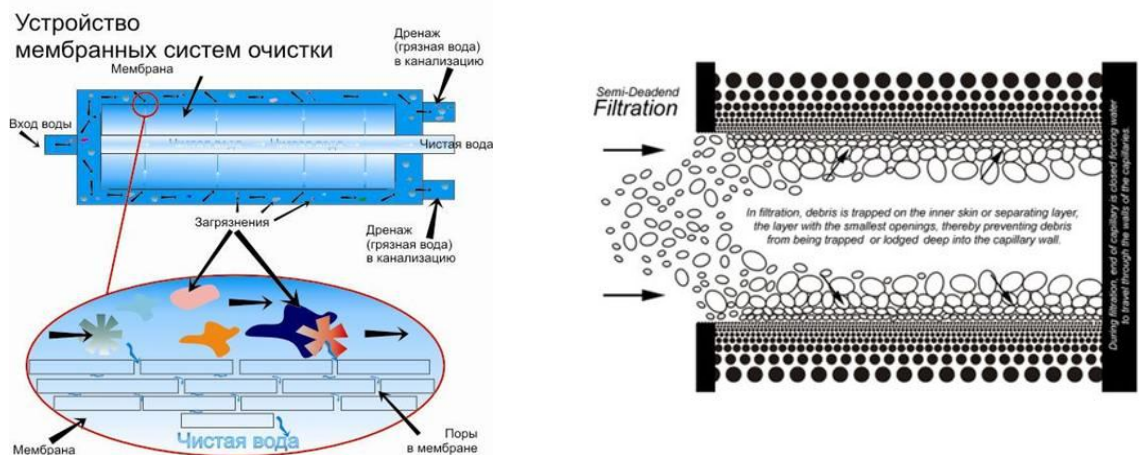

Fig. 4. Membrane cleaning

Electroultrafiltration - is an ultrafiltration in an electric field.

The table shows the relative speed purification of colloidal solutions:

Table 2

Relative purification speed of colloidal solutions

Method	Relative speed of removed substances	
	Salt	Sugar
dialysis	1	0,3

electrodialysis	163	2
ultrafiltration	14	14
electroultrafiltration	182	14

5. Molecular kinetic and optical properties of colloidal systems.

Brownian motion. Colloidal particles in molecular- kinetic properties are not fundamentally different from true solutions. Suspended particles in the solution are in constant random thermal motion (Brownian motion - opened in 1827 by the British botanist R.Broun watching as microscopic particles of pollen and spores continuously and randomly move in the water). The collision of particles is an exchange of energy and as a result sets the average kinetic energy which is the same for all particles. Molecules (e.g., gas) are moving at speeds of several hundred meters per second, the colloidal particle size of 3-5 microns - fraction of a millimeter per second, due to their huge by microphotography cinematic looks like broken line (Fig. 5).

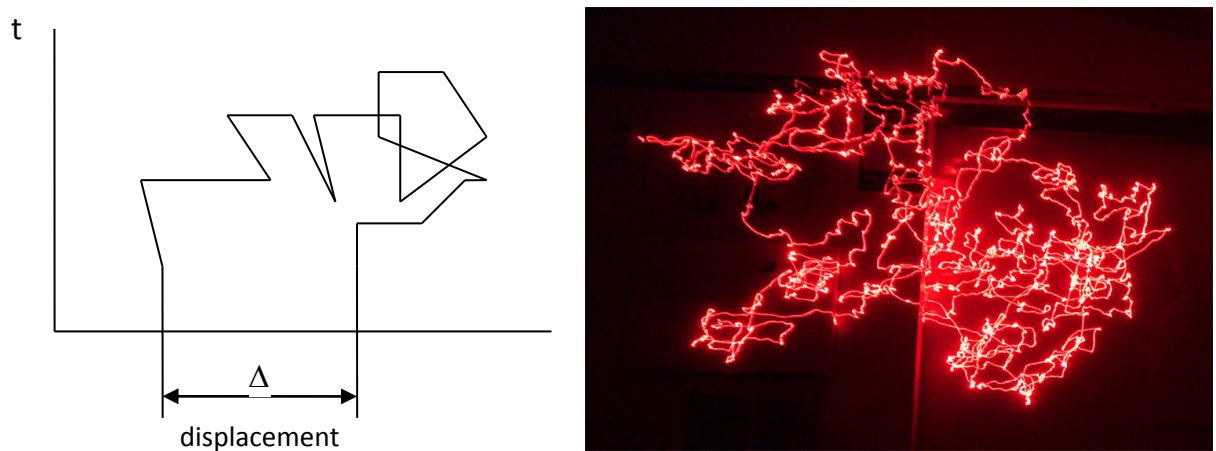

Fig. 5. The movement of particles in Brownian motion.

The quadratic mean of all placements excluding the direction of motion is:

$$\bar{\Delta} = \sqrt{\frac{\Delta_1^2 + \Delta_2^2 + \dots + \Delta_n^2}{n}}$$

n - the number of displacements (the number of segments of the broken line);

Δ_i - individual displacement projection of particle on the x axis.

Elementary study of Brownian motion were carried by Zsigmondy R., J. Perrin, T. Svedberg, and the theory of this movement was developed by Einstein and Smoluchowski (1905).

Einstein-Smoluchowski equation for the quadratic mean displacement of a particle at time t in Brownian motion has the form:

$$\overline{\Delta}^2 = \frac{RT}{3\pi \cdot \eta \cdot r \cdot N_A} \cdot t$$

R - universal gas constant;

T - absolute temperature;

η - viscosity of the medium;

r - radius of the suspended particles;

N_A - Avogadro constant;

t - time.

Conclusion followed from the equation - the larger the particle is, the smaller is the value of its displacement.

Besides the translational motion the particles have also rotational movement.

For rotational Brownian motion of spherical particles the quadratic mean of the angle of rotation will be:

$$\overline{\varphi}^2 = \frac{RT}{4\pi \cdot \eta \cdot r^3 \cdot N_A} \cdot t$$

Einstein's theory has received numerous and compelling evidence.

For example, a brilliant confirmation of the theory is the work of Perrin, who in experiments used spherical particles of mastic with exactly known radius 1 micron. Measuring on this ash translational and rotational motion of

particles in the known values of T and η Perrin calculated Avogadro constant $N_A=6,5 \cdot 10^{23}$.

Diffusion - spontaneous alignment process of particle concentration throughout the volume of solution or gas under the influence of heat (or Brownian) motion.

Einstein studying the Brownian motion established communication of the diffusion coefficient - D with an average shift:

$$\overline{\Delta^2} = 2D \cdot t$$

Einstein showed that the diffusion coefficient D is related to the size of the diffusing particles by equation:

$$D = \frac{RT}{6\pi \cdot \eta \cdot r \cdot N_A}$$

where r – the radius of the spherical particles whose size is much larger than the size of the solvent molecules.

Einstein's equation for the diffusion coefficient is a major in colloid chemistry: it can be used to calculate the particle size of the sols and polymer molecular weight. For this it is only necessary to experimentally determine the diffusion coefficient. Wherein the rate of change of concentration in the layers of solution is measured (the concentration is often determined by optical methods - the refractive index and the absorbance of the solution, etc.).

Dimension D – m^2/s .

At 20 °C: for saccharose $D=4,6 \cdot 10^{-10} m^2/s$, for colloidal particles $D=5 \cdot 10^{-13} m^2/s$.

The physical meaning of the diffusion coefficient is the following - the coefficient is equal to the mass of a substance diffusing in the unit of time through unit area at a gradient of concentration equal to unity.

Osmotic pressure in colloidal systems is a very small amount difficultly reproducible in experiments. The concentration of sols are small and usually no more than 1 %. And as colloidal particles are much more larger than molecules,

the number of particles - individual kinetic units – is small and osmotic pressure is also small.

Osmotic pressure in colloidal systems is inversely proportional to the cube of the particle radius :

$$\frac{\pi_1}{\pi_2} = \frac{r_2^3}{r_1^3}$$

where π_1, π_2 – osmotic pressure in sols of the same material with different dispersion particles.

The slightest violation of aggregate stability of the colloidal system causes a sharp reduction of the osmotic pressure. Determination of osmotic pressure is performing by osmometers (Fig. 6)

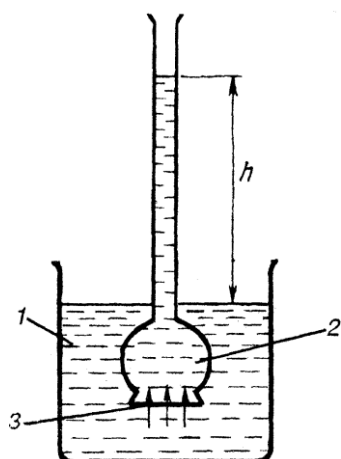

Puc. 6. Scheme of osmometer

1 — water; 2 — solution; 3 — a semipermeable membrane

Sedimentation in disperse systems. Sedimentation (from Lat. Seditimentum - sediment) is the process of subsidence of particles of dispersed phase in a liquid or gaseous medium under the influence of gravity.

Floating particles (e.g., emulsions, drops) is called the inverse sedimentation.

Sedimentation rate of the particles follows the Stokes law:

$$v = \frac{2g(\rho - \rho_0) \cdot r^2}{9\eta}$$

ρ and ρ_0 - medium and particles density;

η - viscosity of the medium;

r - radius;

g - gravity acceleration.

If the difference is $(\rho - \rho_0)$ negative, the medium particles are lighter and float.

Measuring the sedimentation rate the radius of the particles can be calculated (sedimentation analysis):

$$r = K \cdot \sqrt{v},$$

$$\text{where } K = \sqrt{\frac{9\eta}{2g(\rho - \rho_0)}}$$

Ability to sedimentation is often expressed through sedimentation constant S_{sed} :

$$S_{sed} = \frac{v}{g}$$

where v – sedimentation rate;

g - acceleration of free fall.

The unit of S_{sed} - Svedberg ($1\text{Sb} = 10^{-13}\text{s}$) or second.

The reciprocal of the sedimentation constant is a measure of the kinetic stability of the system:

$$\frac{1}{S_{sed}} = \frac{g}{v}$$

Large particles sedimentate firstly, then - the smaller where in the particles are stacked in layers.

Brownian motion prevents sedimentation and diffusion.

Steadied state is called sedimentation-diffusion equilibrium.

For sedimentation analysis of kinetically stable systems (sol solutions CPA) to determine the size and mass of the particles force gravity is not enough.

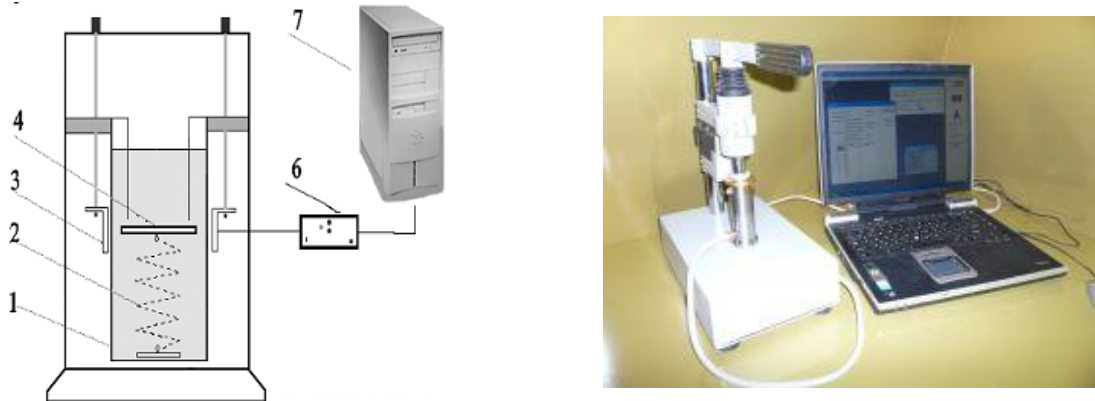

Fig..7. Device for sedimentation determining

A.V. Dumanskiy (1912) proposed to centrifuge colloidal systems.

Swedberg (1923) developed a special centrifuge with great speed, called the ultracentrifuge .

Modern ultracentrifuge give an ability to obtain a centrifugal force that exceeds the acceleration of gravity in 10^5 times.

Modern ultracentrifuge is a complex apparatus whose central part is rotor (with speed 20-60000 rev / min and above) with the finest temperature control and optical monitoring system for the sedimentating .

The speed of sedimentation of particles in the ultracentrifuge is calculated by Stokes equation :

$$v = \frac{2g(\rho - \rho_0) \cdot r^2}{9\eta}$$

changing g to $\omega^2 x$:

$$v = \frac{2\omega^2 \cdot x \cdot (\rho - \rho_0) \cdot r^2}{9\eta}$$

where ω – angular speed of the rotor;

x - distance from the particle to the axis of rotation.

Ultracentrifuges are used for the study of colloidal systems: determining sizes, particle shape, and preparative separation and isolation of those fractions with different properties (including viruses, proteins, nucleic acids).



Fig. 8. Ultracentrifuges

Common structural feature of centrifuges is a horizontal arrangement of the axis of the rotor 5, the shaft 7 of which rotates in roller bearings 6 mounted in the frame 8. Drive centrifuge is implemented by an electric motor through a belt drive. On the front cover of centrifuge is mounted sediment slice mechanism 3, discharge hopper 1, feed pipe 2.

Optical properties of disperse systems. Historically during the study of disperse systems people primarily paid attention to their optical properties. A large contribution to this made Faraday, J. Tyndall, JW Relley etc.

Disperse systems have special optical properties.

Special optical properties of disperse systems due to their main features: dispersion and heterogeneity.

The passage of light through the dispersion system is accompanied by such phenomena as refraction, absorption, reflection and straggling.

These phenomena depend on the ratio of the wavelength of the incident light to the size of the particles: $\frac{\lambda}{r}$.

In coarse systems $r > \lambda$ light reflects from the surface. Reflection is possible only in the suspended systems. Reflection is manifested in turbidity of systems (observed in the forward and lateral illumination).

In highly dispersed sols r is commensurate with λ and light scattering is observed.

Light scattering. This is the most characteristic optical property of colloidal systems. The light scatters in all directions.

This phenomenon was observed by Faraday (1857) in the study of gold sol.

The phenomenon was described by Tyndall in 1868.

Through pure liquids and molecular solutions the light just passes. Through colloidal dispersions with particle size 10^{-7} - 10^{-9} m beam of light meeting on the way a particle is not reflected, it skirts it, and is rejected and changes its direction a bit (diffraction) .

The smaller the wavelength of the light beam is, the greater the deflection angle is.

Tyndall found while illuminating colloidal solution by bright light beam it's path is visible when viewed from yhe side as a luminous cone - Tyndall cone.

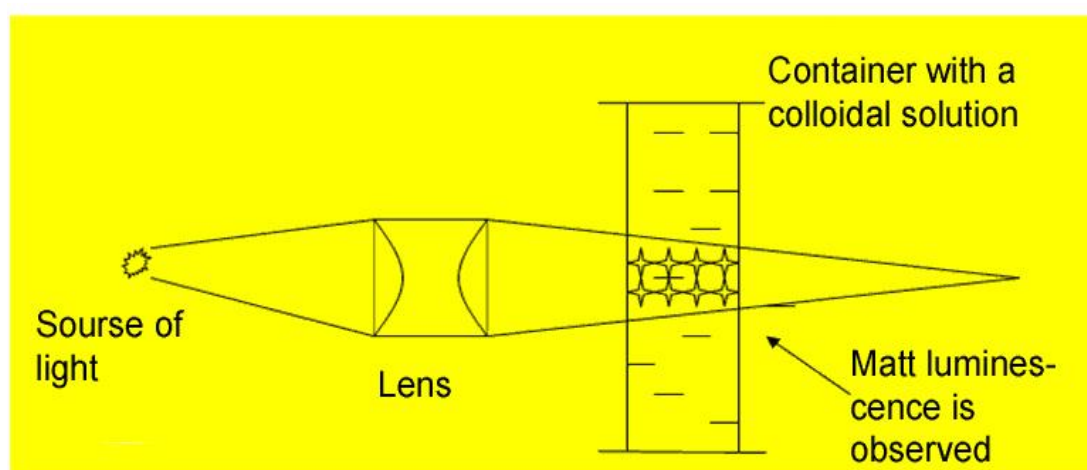

Fig. 9. Observation of Tyndall cone.

This phenomenon is called **opalescence** (from the colour of opal: milky blue colour) - frosted glow, often bluish. Used to identify colloidal systems



Fig. 10. Light scattering

Opalescence should be distinguished from fluorescence – the glow of true molecular solutions of certain dyes in transmitted light. The reasons of fluorescence is the intramolecular excitation.

The theory of light scattering was developed by Raul (1871) for spherical, non-conductive electrical current particles (dilutions).

Rayleigh equation has the form:

$$I_p = 24 \cdot I_0 \cdot \pi^3 \cdot \frac{\nu \cdot V^2}{\lambda^4} \cdot \left(\frac{n_1^2 - n_2^2}{n_1^2 + 2n_2^2} \right)^2$$

I_p - intensity of scattered light;

I_0 - the intensity of the incident light;

n_1 and n_2 - the refractive indices of the dispersed phase and the dispersion medium;

ν - partial concentration (number of particles in unit of volume);

V - the volume of particle;

λ - the wavelength of the incident light.

Some conclusions from Raul's equation:

1. In case of equality of the refractive indices of the medium and the particles ($n_1 = n_2$) I_p vanishes –no light scattering.

2. The smaller the wavelength of the incident light (λ) is the scattering will be.

If on the particle falls white light, the most scattered are blue and purple components (in transmitted light solution is painted in a reddish color in the lateral reflection - in blue).

Dispersions are transparent with respect to the long-wavelength region of the spectrum (red, orange, yellow).

With respect to short-wavelength (purple, green, blue) - opaque.

Traffic light is clearly visible in the fog (red, orange - the color of danger) .

Blue lamp is not visible from the plane (masking) .

Blue sky in the afternoon - short wave scattering of sunlight of earth's atmosphere .

Red sky at sunrise and sunset - there is light passing through the atmosphere.

3. Maximum light scattering occurs in the systems having a particle size $r < (2-4) \cdot 10^{-8}$ m which corresponds to a colloidal dispersion.

With increasing particle size to greater than the wavelength - there is the reflection of light. Opalescence disappears, turbidity appears. That area of the particle size, where the intensity of the scattered light is maximal is called Raul's area.

4. Raul's equation allows to:

- to determine the concentration V if the radius r and the volume V of the particle is known;

- to determine the radius and volume of the particle if the concentration is known.

The dependence of the scattered light intensity on concentration of dispersed particle and its sizes is used in research and laboratory practice.

Method of chemical analysis based on measuring the intensity of light scattered by disperse system is called nephelometry .

To observe colloidal particles conventional microscopes are not suitable. In 1903 . Austrian chemist R. Zsigmondy together with the German physicist Siedentopf created a special method of investigation - ultramicroscopy. In ultramicroscopy colloids are illuminated from the side (side lighting) and are observed as luminous dots on a black background.

6. Electrokinetic properties of disperse systems.

Theory of the formation and structure of DEL.

The existence of the double electric layer (DEL) of ions and the potential jump at the interface of the two phases plays an important, and sometimes - a major role in many phenomena important for theory and practice. These include: the electrode processes, electrocapillary and electrokinetic phenomena, phenomena associated with the electrostatic interaction of colloidal particles, largely determining the stability of the dispersed system. All these phenomena interconnected through DES are called electrosurface phenomena.

Consider the phenomenon occurring at the interface - the emergence of the electric double layer, which determines the various electrosuperficial phenomenon.

There are three possible mechanisms for the formation of DEL:

- due to the transition of electrons or ions from one phase to the other (surface ionization);
- as a result of selective adsorption in the interfacial layer of electrolyte ions;
- as a result of the orientation of the polar molecules of conjugated phases in their interaction.

- According to the first mechanism, the charge on the surface can be formed by electrolytic dissociation of the solid phase surface, whereby ions of the same sign remain in a fixed position on this surface, and counterions (ions of opposite sign) enter the adjacent solution. By this mechanism DEL occurs in solution of a number of high-molecular compounds

By the second mechanism, the ions of same sign are nonexchange adsorbed by the surface, and the ions of the opposite sign, due to electrostatic attraction, are located near it. The magnitude and sign of the surface charge depends on the particulate nature of the adsorbent and on the nature of liquid which it contacts.

Review the circuit of structure of DEL according to different theories.

First picture of DEL was expressed by Kvinke (1859) and developed in the works of Helmholtz (1879) .

DEL theory was developed in the works of scientists of the USSR of A.N. Frumkin and B.V. Deryagin.

The first theory was the theory of the structure of DEL of Helmholtz: DEL consists of two flat charges located at the molecular distance from one another and interact with each other only by electrostatic forces of gravitation. Structure is similar to the plate capacitor, potential drop between the layers is linear .

Gouy-Chapman model assumed counter diffusion location under the influence of forces acting in opposite directions: the electrostatic forces of gravitation to the surface and forces of the thermal motion of the ions leading to diffusion and erosion of the outer layer. The theory introduces the concept of the diffusion layer, the ions are treated as point charges that do not have their own size.

According to modern concepts (Stern's theory) DEL structure is following: ions included in the solid phase form the inner lining of the double layer; ions of the opposite sign, i.e. counterions form an outer lining, wherein the counter part is in direct contact with ions of the solid phase forming a dense layer

(Helmholtz layer, the adsorption layer), and another part is counter-diffused layer (Gouy's layer).

The whole system is always electroneutral, i.e. the number of charges of internal lining must be equal to the number of counter charges (dense layer + excess in the diffusion layer).

Within DEL operates the electric field, which intensity is characterized by the value potential. The potential change in DEL depending on the distance is shown in Fig. 11.

In this case the potential drop within the dense layer is linear, and in the diffusion layer - exponentially.

Nowadays the study of DEL is developing, as it is important for the understanding and improvement of such practically important processes as coagulation of colloids, flotation, ion exchange, etc.

Formation of a double layer of ions leads to a certain electrical potential at the boundary of the solid and liquid phases.

On a solid surface arises charge called φ -potential.

Sign φ -potential coincides with the sign of the charge of ions generating the potential.

φ -potential can be calculated by the Nernst equation:

$$\varphi = \frac{RT}{Fz} \cdot \ln \frac{a_o}{a_p},$$

Where:

φ - electrical potential of the surface;

R - universal gas constant;

T - absolute temperature;

z - the charge of ions generating the potential;

F - Faraday constant ($N_A \cdot e$)

a_o and a_p - ions activity on the surface and in the solution.

ϕ -potential equals to the work transfer unit (elementary) charge from infinity to the surface of the solution volume of the solid phase.

Electrokinetic potential. The potential at the surface - ϕ is called a thermodynamic potential and characterizes the potential drop at the interface between the phases.

Potential at the interface of potential ϕ and the so-called plane as close as possible (within a distance of the order of molecular dimensions Δ) ϕ_0 belong to the category of almost immeasurable value. To characterize the electrical properties of the surface is used ζ - potential - potential of slip boundary phases determined experimentally by various methods (method of potential flow, the electrophoretic method, etc.) .

ζ - potential can be represented as the work necessary for the transfer of charge from the unit element of an infinitely distant volume of solution to the sliding surface .

ζ - potential sign coincides with ϕ - potential.

Potential of slip boundary is lower than the potential on the surface, however the magnitude of ζ - potential is widely used to characterize properties of the surface when considering the adsorption, adhesion, aggregation stability of dispersed systems, and other critical processes.

Influence of electrolytes on the electrokinetic potential.

The value of the zeta potential depends on the number of uncompensated charge on the sliding surface adsorption layer, i.e. the number of ions in the diffuse layer.

The thickness of the electric double layer and zeta potential value depends on the electrolyte concentration in the solution.

Changing the thickness of DEL by adding electrolyte to the solution is caused by the fact of changing in the solution the relations between the influence of electrostatic attraction and diffusion determining the distribution of ions in the outer facing of the double layer change.

Cations exert more downward effect (with a negative sign of the surface charge) as higher the valence is. This effect can be explained by the fact that with the increasing of the ion charge increases electrostatic attraction force to its surface, and ions of higher valencies can come closer to the surface, thereby causing a greater compression of the diffusion layer and thus lowering of ζ -potential.

Multivalent ions can not only reduce the value of zeta potential but also to change its sign, i.e. produce surface overcharging. This is due to their high specific adsorption capacity: strongly electrostatically attracting to the surface multivalent cations neutralize its charge, further over equivalent adsorption of cations by surface leads to the appearance of excess positive charge at the interface which will again be offset by negative counterions, so that on the surface will create a new electric double layer with the positive inner coating and negative counterions layer.

Tetravalent metals such as zirconium already provide in a small amounts a sharp decrease of zeta potential, the minimum increase of the concentration of the metal surface leads to overcharging and increasing the values of ζ - potential.

7. The structure of micelle

According to the standard theory of the structure of micellar colloidal solutions the sol consists of 2 parts :

1. A micelle - colloidal structural unit (particle of dispersed phase) surrounded by an electric double layer.
2. An intermicellar liquid - dispersion medium separating micelles which dissolves electrolytes, non-electrolytes and SAS.

Micelle structure can be viewed only at the first approximation because it has no specific composition. Currently, there is no possibility to consider the influence on the structure of the micelle processes caused by the ion-molecule complex interaction at the interface of the two phases in the solution.

Look on excluding the influence of intermicellar liquid micelle simplified diagrams of silver iodide prepared by reacting :

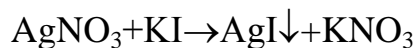

Excess of AgNO_3

Excess of KI

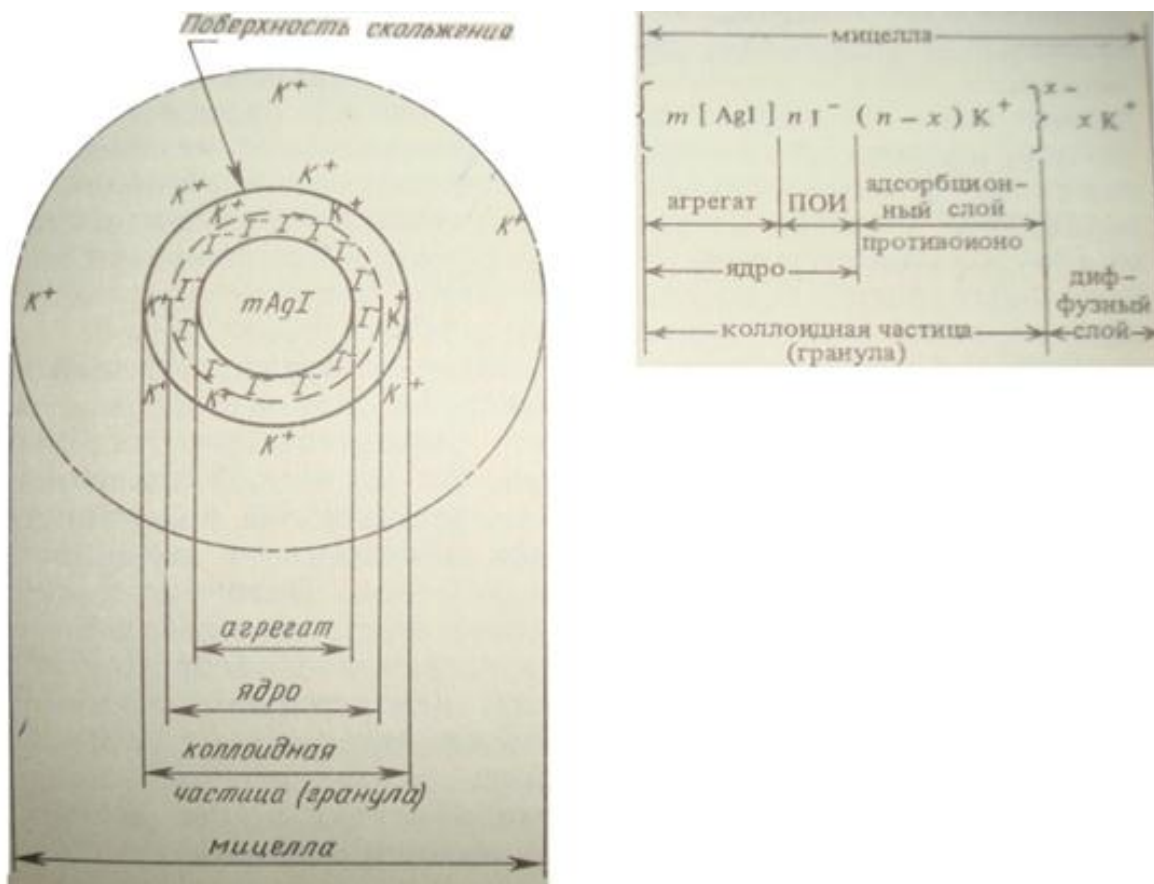

Fig..12 Micelle structure.

Elementary colloid particle - micelle - has the following structure:

- embryo is located on the center which is a microcrystal or aggregate of microcrystals; the surface of the fetus has a free energy margin and selectively adsorbs ions from the environment.

Paneth - Fajans rule: on the solid surface are preferably adsorbed ions which are capable of complete construction of its crystal lattice forming ions or forming part of the crystal lattice of the most soluble compound.

- nucleus with potential- ions form a unit (2);

- after a charge appearance unit begins to attract ions from the solution with the opposite sign (counter) - electric double layer is formed ;

- at the same time some ions attract very strongly to the unit forming an adsorption (dense) layer of counterions. The unit with the counterions of the dense layer compounds granule or particle (3). Particle is characterized by an electric double layer consisting of a potential-determining ions and counter-dense layer, which algebraic sum defines the charge of the system;

- counterions which are not included in the dense layer and are farther away from the nucleus form a diffuse layer of counterions. All together is a micelle, an electrical charge is equal to zero.

8. Electrokinetic phenomena.

This phenomenon associate with the motion of the dispersed phase and the dispersion medium.

To electrokinetic phenomena are phenomena of electrophoresis and electroosmosis, and the potential of sedimentation and flow potential.

The presence in particles of dispersed systems of electric charge was discovered in 1808 by a professor at Moscow University F.F. Reus in studies of water electrolysis.

Reiss put two experiments. In one he used a U- shaped tube, in the second – two glass tubes dipped in a clay.

By passing a direct current through the device consisting of a U- shaped tube, the middle part of which is filled with quartz sand, water in the knee with a negatively charged electrode (cathode) was raising indicating the positive charge of water.

Water was charged in contact with quartz particles. Without diaphragm of sand fluid motion was absent.

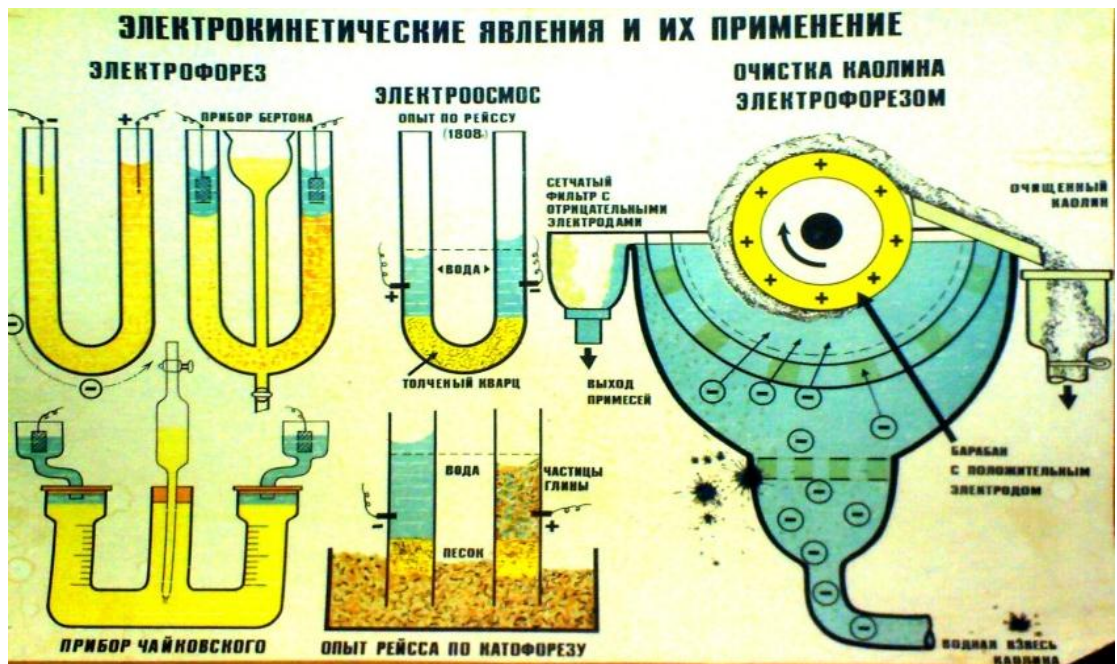

Fig. 13. Application of electrokinetic phenomena

The phenomenon of fluid displacement in porous bodies under the influence of an electric field is called **electroosmosis**.

Phenomenon of electroosmosis is used in industry for water desalination at electrical drainage of porous bodies (concrete, swamps, etc.) for cleaning drugs, in tanning leather, etc.

While creating a potential difference in tubes immersed into the clay, the liquid in the tube with the positive pole becomes cloudy - clay particles are transported in an electric field toward the positive terminal.

Later it was found that the particles move in the electric field with a constant velocity.

The speed is as great as high the potential difference and the dielectric constant of the medium is, and is as small as the high of the viscosity of the medium is.

Movement of dispersed particles in an electric field is called **electrophoresis** (cataphoresis).

Electrophoresis is used in medicine for the introducing of drugs to the organism.

Subsequent studies revealed two phenomena reverseable to electrophoresis and electroosmosis .

In 1878 Dorn found that when settling any particles in a liquid (sand in water) occurs an electromotive force between two electrodes introduced in different places of the liquid column - phenomenon is called Dorn effect or potential sedimentation (settling) .

In 1859 Quincke found that in fluid flow through porous body under the influence of pressure occurs the potential difference. This phenomenon reversible to electroosmosis was called potential leaks or potential flow. The emergence of a potential difference Quincken observed in a water flow and in flow of aqueous solutions through different porous materials (clay, sand, wood, graphite) .

Thus featured causal electrokinetic phenomena are divided into two groups.

The first is the phenomenon in which the relative movement of the phase difference is caused by the electrical potential - electrophoresis and electroosmosis.

The second group of potential events includes current and potential sedimentation in which the electrical potential difference is caused by the relative motion of the phases.

9. Stability and coagulation of colloidal systems

Questions of stability of disperse systems take central place in the colloid chemistry, as these systems are generally thermodynamically unstable.

The stability system is the constancy in time of her condition and the basic properties: the dispersion of a uniform distribution of the dispersed phase in the volume of the dispersion medium and the nature of the interaction between the particles.

The particles of the dispersed system on the one hand experience the action of earth's gravity, on the other hand - they are subject of the diffusion tending to

align the concentration in all points of the system. When occurs the equilibrium between these two forces the particles of the dispersed phase arrange in a certain way relative to the surface of the Earth.

According to the proposal of N.P. Peskov (1920) the stability of disperse systems are divided into two types:

- **kinetic** (sedimentative) resistance - property of dispersed particles to hold in suspension without settling (particle opposition forces of gravity).

(stability conditions - high dispersion of particles of the dispersed phase involved in Brownian motion);

- **aggregate** stability - the ability of the disperse phase particles resist coalescence (aggregation) and thereby maintain a certain degree of dispersion of the phases in general.

According to the stability dispersion systems are divided into two classes:

- Thermodynamically stable (lyophilic colloids);

- Thermodynamically unstable (lyophobic systems) .

First - are spontaneously dispersing and exist without stabilizer. These include solutions of SAS, solutions of the HMS.

Gibbs free energy of the thermodynamically stable system decreases ($\Delta G < 0$).

Thermodynamically unstable systems are sols, suspensions, emulsions ($\Delta G > 0$).

Nowadays distinguish **condensation resistance**: system forms groggy aggregates (flocules) or loose sediments - the particles lose their individual mobility but are retained as such for a long time.

Coagulation

Lyophobic colloids are thermodynamically unstable systems existing due to stabilization of the formation of protective ionic or molecular layers. Therefore, changing the state of these layers may result in buckling and then to excretion of the dispersed phase.

Coagulation - the process of coalescence (fusion) of the colloidal particles forming large aggregates with subsequent loss of kinetic stability.

In the general sense coagulation is a loss of aggregate stability of the dispersed system.

Latent stage of coagulation - very fast - the particle size increases, but not precipitate - discoloration, clouding .

Explicit stage - precipitation, separation of the two phases in the solution. Precipitate is called coagulate .

The final result of the coagulation may have two results: the phase separation and formation of the bulk structure, wherein the dispersion medium is uniformly distributed (system concentration).

In accordance with the results of two different methods of coagulation distinguish their methods of study (first result - optical, for example, the second - rheology) .

Coagulation may be caused by various factors:

- The introduction of electrolytes;
- Heating or freezing disperse system;
- Mechanical action;
- High-frequency oscillations;
- Ultracentrifugation, and other factors.

The most important and studied is the effect of electrolytes.

Action of electrolytes on the coagulation

A number of empirical regularities effects of electrolytes, which are known as coagulation rules:

1. Any electrolytes can cause coagulation, but they have a significant impact at a certain concentration.

Coagulation threshold - the minimum concentration of the electrolyte, causing coagulation (γ , mol / l; sometimes C_k).

The threshold is determined by the coagulation of haze or discoloration on the top of dispersed phase in the precipitate.

The threshold is determined by the coagulation of haze or discoloration on the top of dispersed phase in the precipitate.

2. Schulze-Hardy rule (rule Valence, empirical)

Coagulating action that has an electrolyte ion that has a charge opposite to the charge potential-determining ions micelles (granules) and, coagulating action is stronger, the higher the charge.

$$\gamma = \frac{K}{Z^6}$$

where K - coagulating power (take it as a unit).

According to the rule Schulz - Hardy coagulation value thresholds for counter with charges 1, 2 and 3 correspond as 1:1 / 20:1 / 500, so the higher the charge, the less electrolyte may be required to cause coagulation.

Rule Schulze - Hardy has an approximate character and describes the effect of the ions only inorganic compounds.

3. Among the coagulating action of organic ions increases with increasing adsorption capacity.

4. Among the inorganic ions of the same charge state of coagulation activity increases with decreasing hydration.

Lyotropic series or Hofmeister series - is the order of the ions by their ability to hydrate (water-binding).



5. Very often the beginning of coagulation corresponds decrease zeta potential to a critical value (about 0.03 V).

6. In sediments, resulting in the coagulation of electrolytes, there are always ions that cause it.

The combined action of electrolytes in coagulation.

Mixture of electrolytes in the coagulation of sols rarely act independently. Observed in **this** phenomenon can be reduced to the following three: **additivity, antagonism and synergism** electrolytes.

These phenomena using mixtures of electrolytes are shown in fig 8.

Dependence of γ - characterizes the additive effect of electrolytes. Coagulating action in the mixture is determined by the simple addition rule:

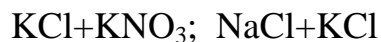

Curve 2 - antagonism electrolytes - the contents of each electrolyte in the mixture exceeds its own threshold concentration

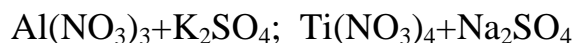

Synergism electrolytes demonstrates curve 3. Increases the effects of each of the electrolytes - for their coagulation requires less mixed than each individually.

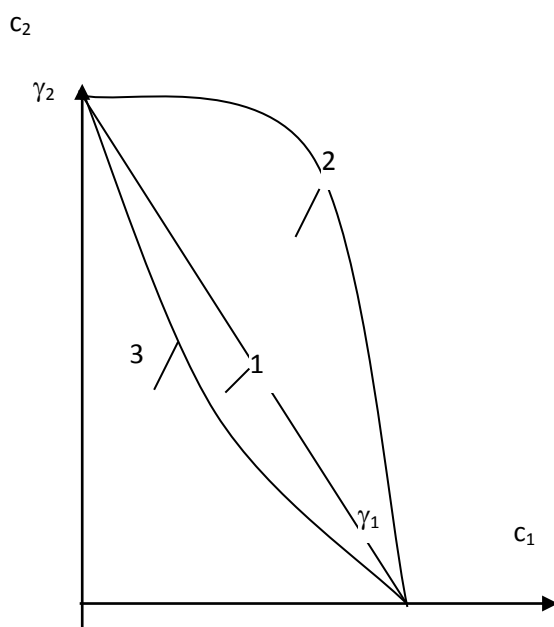
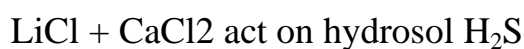

Fig. 14 The combined action of electrolytes in coagulation.

Stability Theory of hydrophobic disperse systems DLVO. Modern physical theory coagulation electrolytes based on the general principles of statistical physics, the theory of molecular forces and the theory of solutions. Its authors are: B.V Derjaguin, L.D Landau (1937-1941), E. Fairways, J. Overbeck (the first letters of the DLVO).

The essence of the theory: between any particles as they approach the disjoining pressure arises separating liquid layer as a result of the forces of attraction and repulsion.

Disjoining pressure is the sum parameter that takes into account the action as the forces of attraction and repulsion forces.

The condition of system depends on balance of energy of an attraction (U_{np}) and energy of a repulsion (U_{ort}). U_{ort} prevails – a stable system. U_{np} - violation of aggregate stability – coagulation.

Interaction energy change between two particles at their rapprochement represent graphically (fig.15)

The total energy of a system of two particles is obtained by adding U_{ort} and U_{br} :

$$U = U_{ort} + U_{np} = B \cdot e^{-\chi \cdot h} - \frac{A}{h}$$

where: B - a factor that depends on the values of the electric potentials EDL, fluid properties, temperature;

e - base of natural logarithms;

χ - the reciprocal of the thickness of the diffusion layer;

h - the distance between the particles;

A - constant molecular attractive forces.

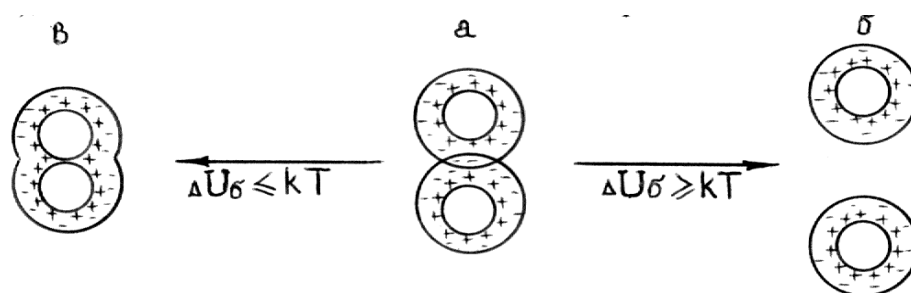

Fig. 15. Scheme of interaction of colloidal particles

Dispersed system of aggregate stability at high energy barrier of repulsive forces.

Coagulation rate. Progress coagulation depending on the concentration of the coagulating electrolyte can be divided into two stages: slow and fast.

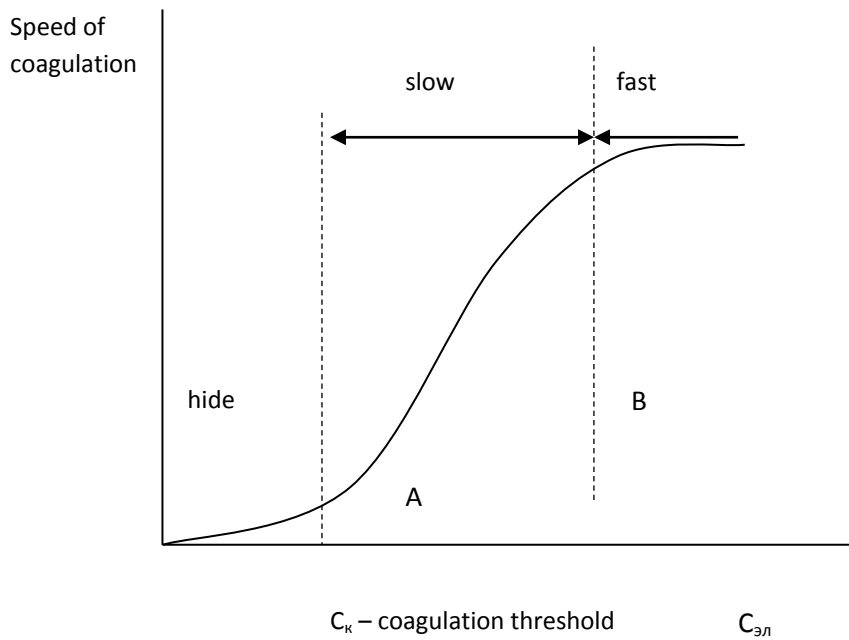

Fig. 16 Dependence of the rate of coagulation of the electrolyte concentration

In the slow coagulation rate strongly depends on the concentration (segment AB). At point B, the speed is constant and does not depend on the concentration of the electrolyte - here meaning ζ - potential is zero - the beginning of rapid coagulation. Electrolyte concentration, from which the coagulation rate remains constant, called the threshold of rapid coagulation.

Coagulation kinetics theory developed by Smoluchowski (1916).

Consider coagulation as a second-order reaction, in the elementary act involving two particles: $v = \frac{dn}{d\tau}$.

Smoluchowski's equation to calculate the number of particles bound together by m-pieces during τ :

$$n_m = n_0 \cdot \frac{\left(\frac{\tau}{\theta}\right)^{m-1}}{\left(1 + \frac{\tau}{\theta}\right)^{m+1}};$$

n_0 - The initial number of particles;

θ - Half-coagulation time (τ_1).

At fast coagulation all faced particles react ($\Delta U_0 = 0$).

Smolukhovsky's equation for a kinetic constant of fast coagulation:

$$K_0 = \frac{4kT}{3\eta};$$

where η -viscosity of the environment.

At sluggish coagulation not all collisions lead to coalescing.

Smolukhovsky's

Smoluchowski's equation for slow coagulation:

$$K_M = \frac{4kT}{3\eta} \cdot P \cdot \exp\left[\frac{\Delta E}{kT}\right];$$

where P - steric factor that allows for favorable spatial arrangement of the particles in the collision, their physical size. With rapid coagulation all collisions are effective and $P = 1$, with slow $P < 1$.

ΔE - potential barrier for rapid coagulation $\Delta E = 0$ at slow $\Delta E \neq 0$.

η -viscosity

Coagulation threshold can be calculated from the ratio theoretically found Derjaguin and Landau and called **law degree 6**:

energy barrier between the colloidal particles disappears at a critical concentration (γ), which is inversely proportional to the sixth power of the ion charge-coalescent:

$$\gamma = \frac{const}{z^6};$$

z-Chargers coagulating ion.

In accordance with this equation, the values for elements γ counter charges 1, 2 and 3 relate as $1:1/2^6:1/3^6 = 1:1/64:1/729$

The equation well proves the rule of thumb Schultz-Gardi.

When the role of an adsorption and solvate factor of stability is great, nearness of the theory of DLVO since it does not consider a role of specific adsorption and affinity of an ion to solvent is shown.

Communication of effectiveness of impacts with a potential hill at coagulation was shown by Fuchs N. A.

If ΔE much more κT , the speed of coagulation can come nearer to zero and the system will be aggregation unstable.

In the theory developed by Fuchs, we use the representation of the coagulation factor slowing W , which shows how many times the rate constant of slow coagulation rate constants less rapid coagulation. Given the expressions for the K_B and K_m , we obtain:

$$W = \frac{1}{P} \cdot \exp\left[\frac{\Delta E}{kT}\right]$$

W factor called factor of stability or stability coefficient.

Aging sols:

Lyophobic colloids have a weak interaction of the dispersed phase and dispersed the environment and are characterized by the dispersion tendency to decrease with time dispersion.

Surplus of the free surface energy received by particles at their formation, is (according to the second beginning of thermodynamics) the main reason for transition to more stable state which is defined by integration of particles.

Spontaneous process of consolidation of the particles (reducing the degree of dispersion) in lyophobic sols called aging or auto coagulation.

Aging speed much more slowly, than coagulation under the influence of electrolytes.

10. Protective effect of molecular adsorption layers

Some systems have a very high resistance, they even acquire the ability to self-formation - colloidal solubility.

In the majority of sols on a demarcation of two phases there are the adsorption layers formed by molecules of SAS. The adsorption layers protect particles from coalescing, but they cover not all surface, and approximately for 40-60%.

The maximal stability is reached at formation of the complete adsorption layer.

Increase of stability of disperse systems under the influence of SAS call the **colloid protection** or **stabilization of colloids**.

As stabilizers use: high molecular SAS gelatin, an albumin, a casein, Amylum, pectin, rubbers, a hemoglobin, etc.

For the quantitative assessment of stabilizing action of this or that colloid of R. Zsigmondi offered a so-called **gold number**.

The gold number is a minimum weight (in mg) stabilizing substance which is capable to protect 10 ml of red sol of gold (to prevent a discoloration red-blue) from coagulable influence 1 ml of 10% NaCl solution.

The smaller the golden number, the greater the protective effect of colloid.

Defined as a protective effect against the silver sols - silver number, congo ruby - Ruby by sulfur - sulfur number etc.

QUESTIONS FOR SELF-TRAINING

- 1 . What do the colloid chemistry and what signs of its objects study?
- 2 . By what signs classify objects of the colloid chemistry? Give examples of disperse systems.
3. What parameters degree of dissociation and what communication between them characterizes?
- 4 . Than the Brownian motion of particles of disperse systems is caused? In what systems probably Brownian motion?
Give examples.
- 5 . Write Stokes's equation for sedimentation speed in a gravitational field. What physical sense of sizes entering it?
What change of parameters of system it is possible to change fall velocity of particles?
- 6 . What is the sedimentation constant and what it characterizes? Write expression for a sedimentation constant of spherical particles if their deposition submits to Stokes's equation.
- 7 . Tell about original positions of the theory of a structure of a double electric layer.
What ratio is cornerstone of this theory?
8. List the electrokinetic phenomena and explain, than they are caused.
9. What call an electrokinetic potential?
What factors influence on ξ -potential negatively the charged particles at introduction in sol of nitrates of a potassium, barium and a lanthanum?
10. Under what conditions the equation of the Helmholtz-Smolukhovsky electrophoresis for speed is applicable? What properties constant liquid has to possess?
11. What represent relaxational effect, electrophoretic braking and the surface conduction?
In what cases they need to be considered at calculation ξ -potential?

12. What phenomenon call solubilization?

Than this phenomenon is caused? What practical value of this phenomenon?

13. Tell about practical application of SAS. On what use of SAS as stabilizers of disperse systems is based? In what the mechanism of a detergent action of SAS solutions consists?

14. What features of dissolution of polymers?

What process is called as swelling? In what cases there is a restricted and unlimited swelling of polymer?

15. Specify characteristics of swelling of polymers in low-molecular liquids. What is the swelling value and how it is defined?

16. How influences pH solution on formula of molecules of polymeric ampholytes?

What is the isoelectric point of polyelectrolytes?

17. Than aggregate instability of lyophobe disperse systems is caused? What processes spontaneously happen in such systems?

18. What methods get lyophobe disperse systems? Give examples.

19. What process is called as coagulation? Than coagulation process comes to the end? In what ways it is possible to cause coagulation of a lyophobe colloid system?

20. What is call fast and sluggish coagulation? What interrelation between the speed of coagulation and a type of a potential curve of interaction of particles?

21. What action of factors provides aggregate stability of lyophobe systems? What substances use as stabilizers of these systems?

22. What is the wedging pressure and what reasons of its emergence? Call components of the wedging pressure.

23. What components of the wedging pressure are considered by DLFO stability theory?

Give examples of potential curves of interaction between particles for disperse systems with various degree of stability.

What features of coagulation in the first and second power minima according to DLFO theory?

24. Disperse systems. Classification by various signs.
25. Methods of obtaining disperse systems.
26. Molecular and kinetic and optical properties of colloids (Brownian motion, diffusion, osmosis, scattering and light absorption).
27. Sedimentation equilibrium and sedimentation stability.
28. Determine the size and weight of the colloidal particles by molecular-kinetic characteristics.
29. Determine the size and weight of a colloidal particle optical properties (ultramicroscopy, nephelometry, electron microscopy).
30. Ultracentrifuge and its use for research of the colloid systems.
31. Emergence of electric charge of the colloid particles and structure of a double electric layer.
32. Structure of the colloid particle (micelle).
33. Electrothermodynamic and electrokinetic potentials. Influence of electrolytes. Particle recharge.
- 34 . Electrokinetic phenomena. Electrophoresis, electroosmosis, course and sedimentation potential.
35. Electrokinetic research techniques in a pharmaceuticals.
36. Kinetic, aggregate, condensation stability.
37. Coagulation, factors its defiant, types of coagulation.
38. Schultz and Gardi's rule. Threshold of coagulation.
39. Alternation of zones of coagulation, coagulation by mixes of electrolytes.
40. Coagulation theory (the adsorption, Landau-Deryagina).
41. The colloid protection, peptization, intercoagulation. Gelation, geletinization.

42. Micelleformation in solutions of the colloid SAS. Critical concentration of micelleformation.

43 . Solubilization and the colloid SAS in a pharmaceutics.

44. Equation Helmholtz-Smolukhovsky.

TASKS

Task #1

Define mean squared shift Δ parts of hydrosol of sulfur for 10 s at 295K if the diffusion coefficient of parts of sol at this temperature is equal $4,7 \cdot 10^{-7} \text{ cm}^2/\text{s}$. To that the radius of parts, if viscosity of media $10^{-6} \text{ Pa}\cdot\text{s}$?

Task #2

The fissile surface of an aerosil makes 600 sq.m on 3 g. To calculate how many molecules of eosine it is adsorbed on 1 sq.m of an aerosil if 1 g of a sorbent adsorbs 8 mg of dye. M. m. of eosine 677.

Task #3

To calculate an electrokinetic potential of particles of sol of a colloid silver if in 3 min. at a voltage of 300V of its particle moved on 20 mm at electrode separation of 10 cm ($\eta = 10^{-3} \text{ Pa}\cdot\text{s}$; $\epsilon = 81$; $\epsilon_0 = 8,85 \cdot 10^{12} \text{ F/m}$).

Task #4

Parts of the powder BaSO_4 of a spherical form settle in one environment on height of 0,266 m for 1250 pages. BaSO_4 and water density respectively 3,5 and 1 g/cm^3 , viscosity of water of $103 \text{ Pa}\cdot\text{s}$. To determine diameter of parts of powder.

Task #5

What volume of 0,02 N of BaCl_2 solution needs to be added to 40 ml 0,004 N of $\text{Al}_2(\text{SO}_4)_3$ what to receive fixed white sol with positively charged parts? To write a formula of a micelle of the received sol.

Task #6

Sol of Hydrargyrum it is put from parts of a conglobate form with a diameter of $6 \cdot 10^{-6} \text{ cm}$. To that is the surface of parts which were formed of $0,600 \text{ cm}^3$ of Hydrargyrum equal?

Task #7

$\text{Fe}(\text{OH})_3$ sol thresholds of coagulation for electrolytes 3M KCl, 0,05 M of K_2SO_4 I, 0,04 M $\text{K}_3\text{Fe}(\text{CN})_6$. 13,0 and 0,4 mmol/l of sol are respectively equal. Compare coagulating capacity of electrolytes.

Task #8

For coagulation of 100 ml of sol of oxyhydroxide of iron it was required to add 10, 10 ml 1N KCl solution. To determine a sol threshold of coagulation by potassium chloride.

Task #9

What volume of 0,01 N of BaCl_2 solution needs to be added to 20 ml 0,004 N of $\text{Al}_2(\text{SO}_4)_3$ what to receive fixed white sol with positively charged parts? To write a formula of a micelle of the received sol.

THE STANDARD ANSWERS

Exercise #1

Parts of the powder BaSO_4 of a spherical form settle in in one environment on height of 0,226 m for 1350 pages. BaSO_4 and water density respectively 4,5 and 1 g/cm³, viscosity of water of 103 Pa • s. To determine diameter of parts of powder.

Solution. On a Stokes law rate of sedimentation of parts equals:

$$u = \frac{2g(p-p_0)r^2}{9\eta}, \text{ so}$$

$$r = \sqrt{\frac{9 \cdot \eta \cdot u}{2 \cdot (p-p_0) \cdot g}} = \sqrt{\frac{9 \cdot 10^{-3} \cdot \frac{0,0226}{1350}}{2 \cdot (4,5-1) \cdot 10^6 \cdot 9,8}} = \sqrt{0,22 \cdot 10^{-10}} = 0,47 \cdot 10^{-5} = 4,7 \text{ mkm.}$$

Exercise #2

Sol of Hydrargyrum it is put from parts of a conglobate form with a diameter of $6 \cdot 10^{-6}$ cm. To that is the surface of parts which were formed of 0,500 cm³ of Hydrargyrum equal?

Solution.

$$r = d/2 = 3 \cdot 10^{-6}$$

Find the volume and surface area of a spherical particle

$$V_1 = \frac{4}{3} \pi r^3 = 1,13 \cdot 10^{-16} \text{ cm}^3;$$

$$S_1 = 4\pi r^2 = 4,5 \cdot 10^{-10} \text{ cm}^2.$$

The quantity n of parts equals:

$$0,5 \div 1,13 \pi \cdot 10^{-16} = 4,4 \cdot 10^{15}.$$

So, sum of a surface area of all parts:

$$4,4 \cdot 10^{15} \cdot 4,5 \cdot 10^{-10} = 1,98 \cdot 10^6 \text{ cm}^2.$$

Exercise #3

The fissile surface of an aerosil makes 300 sq.m on 1 g. To calculate how many molecules of eosine it is adsorbed on 1 sq.m of an aerosil if 1 g of a sorbent adsorbs 4 mg of dye. M. m. of eosine 677.

Solution.

The fissile surface – the maximal surface area of parts of an adsorbent which can be filled with adsorbate.

From a statement of the problem it is visible that 1 m of a surface area of an adsorbent adsorbent 4:300 = 0,0133 mg of eosine that makes:

$$N = \frac{m(r)}{M(r/mol)} \cdot N_{A(1/mol)} = \frac{1,33 \cdot 10^{-5}}{677} \cdot 6 \cdot 10^{23} = 1,179 \cdot 10^{16} molec. = 1,179 \cdot 10^{16} molec.$$

Exercise #4

What volume of 0,01 N of BaCl₂ solution needs to be added to 40 ml 0,003 N of Al₂(SO₄)₃ what to receive fixed white sol with positively charged parts? To write a formula of a micelle of the received sol.

Solution

We count the volume of 0,01 N of the BaCl₂ solution necessary for receiving a deposit of BaSO₄ according to the equation of reaction 3BaCl₂ + Al₂(SO₄)₃ = 3BaSO₄ + 2AlCl₃:

$$V_{BaCl_2} = V_{Al_2(SO_4)_3} / N_{BaCl_2} = 40 \cdot 3 \cdot 10^{-3} / 10^{-2} = 1,2 ml$$

Role of potential-determining ions - stabilizers - can perform ions which are in excess and common atoms or ions precipitate with a substance (typically Paneth Fajans-), namely, the ions Ba²⁺ or SO₄⁻². To obtain sols with positively charged particles necessary to take the excess of barium chloride in comparison with aluminum sulfate, i.e., the volume of solution must be more BaCl₂ 1.2 ml.

Exercise #5

To calculate an electrokinetic potential of particles of sol of a colloid silver if in 5 min. at a voltage of 300V of its particle moved on 10 mm at electrode separation of 20 cm ($\eta = 10^{-3}$ Pa·s; $\epsilon = 81$; $\epsilon_0 = 8,85 \cdot 10^{-12}$ F/m).

Solution

We use a formula Helmholtz-Smolukhovsky where we substitute values of known sizes in a Si-system:

$$\xi = \frac{\eta h L}{\epsilon \epsilon_0 t V} = \frac{10^{-3} Pa \cdot c \cdot 10 \cdot 10^{-3} m \cdot 20 \cdot 10^{-2} m}{81 \cdot 8,85 \cdot 10^{-12} \frac{F}{m} \cdot 5 \cdot 60 c \cdot 300 B} = 0,031 V = 31 mV$$

Exercise #6

For coagulation of 100 ml of sol of oxyhydroxide of iron it was required to add 10, 5 ml 1N KCl solution. To determine a sol threshold of coagulation by potassium chloride.

Solution

$$C_{cr} = \frac{C_{el} \cdot V_{el}}{V_{sol}} = \frac{1 \left(\frac{mol}{L}\right) \cdot 10,5(mL)}{110,5(mL)} = 0,095 \text{ mmol}/L = 95 \text{ mole}/m^3$$

Exercise #7

Fe(OH)₃ sol thresholds of coagulation for electrolytes 2M KCl, 0,05 M of K₂SO₄ 1,0,005 M K₃Fe(CN)₆. 13,0 and 0,25 mmol/l of sol are respectively equal. Compare coagulating capacity of electrolytes.

Solution

Coagulating capacity of electrolytes is defined as size, back to their thresholds of coagulation.

$$V_{cr,KCl} = \frac{1}{C_{cr}} = \frac{1}{13 \frac{mmol}{L}} = 0,077 L/mol$$

$$V_{cr,K_2Cr_2O_7} = \frac{1}{C_{кр}} = \frac{1}{0,25 \frac{mmol}{L}} = 4 L/mol$$

Where $V_{cr,KCl} : V_{cr,K_2Cr_2O_7} = 0,077 : 4 = 1:52$.

So for sol Fe(OH)₃ coagulating capacity of bichromate of a potassium is 52 times higher.

EXPERIMENTAL PART

Laboratory work: Preparation and properties of colloidal systems

Experiment 1. Preparation of sol of iron hydroxide (III) by method hydrolysis.

Heat to boiling distilled water in an amount of 50.0 ml.

Add 10.0 ml of a 2 % aqueous solution of iron chloride (III) and boil for a few minutes.

Write the equation of the reaction and the micelle structure. Determine ion stabilizer.

Experiment 2. Preparation of sol of Prussian blue by method of double exchange.

Prepare two test tubes colloids of Prussian blue of 0,005 N FeCl_3 и 0,005 N $\text{K}_4[\text{Fe}(\text{CN})_6]$ in the following proportions:

1) 3,0 ml FeCl_3 + 1 ml $\text{K}_4[\text{Fe}(\text{CN})_6]$ →

2) 1 ml FeCl_3 + 3 ml $\text{K}_4[\text{Fe}(\text{CN})_6]$ →

Experiment 3. Preparation of manganese dioxide sol.

Add 10 ml of water to 1 ml of 1,5% solution of KMnO_4 in a test tube. Add 0,5 ml of 1% solution of sodium thiosulfate dropwise with pipette.

Write the equation of the reaction and the formula of a micelle sol of the manganese dioxide.

Experiment 4. Determining the threshold coagulation negatively charged sol of Prussian blue.

Prepare 50 ml of a negatively charged sol of Prussian blue (see previous experiment).

In 4 tubes add 10 ml sol and put in a tripod.

Leave the first test tube for the control, add to the second test tube dropwise from a burette until the 4 M solution of the KCl will be turbid, add to the third test tube solution of 0,01 M MgCl_2 , add to the fourth test tube 0,001 M solution of AlCl_3 .

Electrolyte	Coagulating ion	Sol volume in ml	The smallest amount of electrolyte, causing coagulation	Coagulation threshold
4M KCl				
0,01 M MgCl ₂				
0,01 M AlCl ₃				

Calculation of the coagulation threshold: $C_{coagul} = \frac{C_{el} \cdot V_{el}}{V_{sol}} =$

C₁=

C₂=

C₃=

C₄=

Laboratory work: Determination of zeta potential of sols

Collect appliance of Tchaikovsky and fix it on the tripod Connect the electrodes to the electronic power adapter. Add distilled water to appliance of Tchaikovsky by 1/3 lateral knee, then enter analyzed sol using a pipette to form precise interface between the water and a layer of sol. Mark the position of the interface on the tube of Tchaikovsky appliance. Put the electrodes into the aqueous layer and turn on electronic power adapter to the AC line, set the voltage between the electrodes 250 V and note the start of electrophoresis.

WARNING!

Don't touch hands to the electrodes after connecting electronic power adapter.

Determine way passed the interface for 10 minutes, the distance between the electrodes.

Calculation of zeta potential using formula:

$$\zeta = \frac{4\pi\eta U_{em}}{\varepsilon} = \frac{\eta U_{em}}{\varepsilon\varepsilon_0} \qquad U_{em} = \frac{SI}{tE}$$

where

ζ - zeta potential;

η - viscosity of the medium, (Pa·s);

U_{em} - electrophoretic mobility, (m²/V·s);

ε - dielectric permittivity;

ε_0 - electric constant (8,85·10⁻¹²F/m);

S - displacement of the interface (m);

l - electrode distance (m);

t - time (c);

E - applied voltage (V);

$$\frac{4\pi\eta}{\varepsilon} = 1,4 \cdot 10^6 \quad \zeta = 1,4 \cdot 10^6 \cdot U_{em} (B)$$

$$\zeta = \underline{\hspace{10em}}$$

TESTS

How the viscosity of solutions of protein influences by pH value? (N-viscosity)

- a) *The least viscosity of solutions of protein at pH(iep) with magnification of pH grows;
- b) Viscosity grows up to $n(\text{spec})$ with magnification of pH;
- c) The viscosity grows is decreased up to $n(\text{relat.})$

The specific viscosity of polymers is determined on a Staudinger equation: (N-viscosity)

- a) $*n(\text{spec}) = E \cdot I \cdot N$
- b) $n(\text{spec}) = N \cdot E / I$
- c) $n(\text{spec}) = [n] \cdot K \cdot M$

Determination of an isoelectric point of protein is:

- a) *This significance of pH, at which one protein is in an isoelectric state, i.e. the sums positive and negative charges are equal;
- b) This is a system condition, when pH corresponds to the cationic form of protein;
- c) The value of pH, at which one protein is in the anionic form.

In an isoelectric state the protein have:

- a) *The least degree of a bloating;
- b) The greatest degree of a bloating
- c) pH does not influence a degree of a bloating of protein.

The threshold concentration is determined on an equation:

- a) $*C_{(\text{thresh.})} = (C \cdot V / W) \cdot 1000$;
- b) $C_{(\text{thresh.})} = N \cdot V \cdot 100$;
- c) $C_{(\text{thresh.})} = C \cdot V / 100$

How the value a zeta - potential influences stability of sols?

- a) *Than more zeta-potential, the higher stability of salt
- b) Than more zeta-potential, the less stability of salt

In an isoelectric state of a colloidal micelle:

- a) *Zeta-the potential of a pellet is equal to zero point
- b) Zeta-potential is maximal
- c) Zeta-potential is equal to half of initial value.

Whether can the zeta-potential under influencing of ectogenic electrolytes to change the magnitude and sign of a charge?

- a) *Yes
- b) No

Where there is a zeta-potential?

- a) *On border between adsorptive and diffuse strata;
- b) On border of a core and potential of negatively ionized atoms;
- c) On border between SFI and counterions

What is the ratio between a zeta- and e-potential?

- a) *The zeta-potential always is only part of a e-potential;
- b) They are equal;
- c) The zeta-potential is greater than e-potential

Coagulative operating have the ions having a charge:

- a) *Opposite to a charge of a pellet;
- b) Equal to a charge of a pellet;
- c) Identical on the sign to a charge of a pellet

The intercoagulation is supervised, if:

- a) *To drain 2 sols containing pellet with opposite charges;
- b) To drain 2 sols equally charged to add inert electrolyte

What deflocculant is necessary for taking to receive negatively charged sol of AgI, obtained on reaction:



- a) *KI
- b) K_2SO_4
- c) AgNO_3

Value of a zeta - potential is calculating under the formula: (Z- zeta potential; n- viscosity; D-inductivity)

- a) $*Z=4InLU/DE$
- b) $Z=4IDE/n U$
- c) $Z=4InD/ELU$

Sol have been received with the help of reacting:

$\text{AgNO}_3 + \text{KI} \Rightarrow \text{AgI (settlings)} + \text{KNO}_3$. That the charge of a pellet was positive, what deflocculant needs to be taken?

- a) * AgNO_3
- b) NaNO_3
- c) $\text{Al}(\text{NO}_3)_3$

Please indicate valid pattern of sol of sulphide of arsenic. Deflocculant: H_2S .

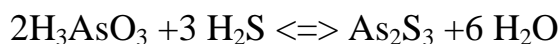

- a) $*\{[\text{mAs}_2\text{S}_3 * n \text{HS}^-] (n-x) \text{H}^+\}^{x-} x\text{H}^+$
- b) $\{[\text{mAs}_2\text{S}_3 * n \text{HS}^{2-}] 2 (n-x) \text{H}^+\}^{2x-} 2x\text{H}^+$

What there will be by the deflocculant of sol of dioxide of manganese, if $\text{C}(\text{KMnO}_4) = 2 \%$, and $\text{C}(\text{sodiumthiosulphate}) = 1 \%$? The volumes are equal.

- a) *Permanganate
- b) Thiosulphate

How correctly to record a constitution of a micelle, if the sol is obtained by a method of reduction:

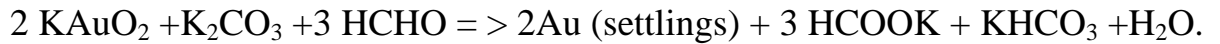

The deflocculant: $\text{EAuO}_2 \text{K}^+ + \text{AuO}^{2-}$

- a) $\{ [m \text{Au}^* n \text{AuO}^{2-}] (n-x) \text{K}^+ \}^{x-} x \text{K}^+$
- b) $\{ [m \text{Au}^* n \text{K}^+] (n-x) \text{AuO}^{2-} \}^{x+} x \text{AuO}_2$
- c) $\{ [m \text{AuI}_2^- (n-x) \text{K}^+] (m-x) \text{AuO}_2$

Please indicate an exact constitution of a micelle of sol of manganese dioxide obtained on reacting:

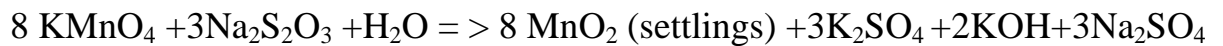

- a) $\{ [m \text{MnO}_2^* n \text{MnO}^{4-}] (n-x) \text{K}^+ \}^{x-} x \text{K}^+$
- b) $\{ [m \text{MnO}_2^* n \text{Mn}^{2+}] (n-x) \text{K}^+ \}^{x+} x \text{K}^+$
- c) $\{ [m \text{MnO}_2^* n \text{S}_2\text{O}_3^{2-}] 2 (n-x) \text{Na}^+ \} 2x \text{Na}^+$

Please indicate a constitution of sol of the Berlin glaze obtained from: FeCl_3 and $\text{K}_4[\text{Fe}(\text{CN})_6]$, deflocculant: $\text{K}_4[\text{Fe}(\text{CN})_6]$

- a) $\{ [m \text{KFe} [\text{Fe}(\text{CN})_6] n [\text{Fe}(\text{CN})_6]^{4-}] 4(n-x) \text{K}^+ \}^{4x-} 4x \text{K}^+$
- b) $\{ [m \text{KFe} [\text{Fe}(\text{CN})_6] n \text{Fe}^{3+}] 3(n-x) \text{Cl}^- \}^{3x+} 3x \text{Cl}^-$
- c) $\{ [m \text{K}_4[\text{Fe}(\text{CN})_6] n \text{K}^+] (n-x) [\text{Fe}(\text{CN})_6]^{4-} \}^{4x+} x [\text{Fe}(\text{CN})_6]^{4-}$

Relay equation for intensity of unpolarized light, dissipated by sols: (L- wave length; D-frequency)

- a) $I = I_0 K D V^2 / L^4$
- b) $I = I_0 C V^2 / L^4 K$
- c) $I = I_0 (n_1 - n_2) K V^2 / L$

What is the dependence between intensity of scattered light and wave length of a polarized light driving through sol?

- a) *Inversely proportional the dependence I from L^4
- b) I is proportional to L
- c) I does not depend from L

Is the Tyndall-Faraday effect a general optical property of all salts?

- a) *Yes
- b) No

The micelle of sol has a constitution:

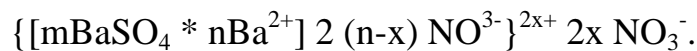

The least threshold of coagulation will be at attachment:

- a) * PO_4
- b) Na^{2+}
- c) Cl^-

Structure of a micelle of sol of pentatione acid:

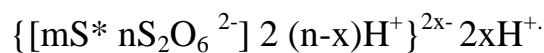

The least threshold of coagulation will be at attachment:

- a) * Al^{3+}
- b) K^+
- c) SO_4^{2-}

The method of peptization is referred to:

- a) *Dispergation methods
- b) Condensation methods

The synthetic kidney device works by a principle of:

- a) *Compensatory dialysis

- b) Electrodialysis
- c) Ultrafiltration

The degree of dispersion of colloidal solutions is:

- a) * $D \sim 10^{-9} - 10^{-7} \text{ m}^{-1}$
- b) $D \sim 10^{-10} \text{ m}^{-1}$
- c) $D \sim 10^{-6} \text{ m}^{-1} - 10^{-4} \text{ m}^{-1}$

How the sol will be charged, if it is obtained on dual interchange reaction:

$\text{AgNO}_3 + \text{KI} \Rightarrow \text{AgI} + \text{KNO}_3$, if the deflocculant takes agent NaI?

- a) *Negatively
- b) Positively
- c) Neutral

Structure of a micelle of sol of gold: $\{[m \text{Au} \cdot n \text{AuO}_2]^{-(n-x)} \text{K}^+\}^{x-} x \text{K}^+$. What ion will coagulate this sol better?

- a) * Al^{3+}
- b) Na^+
- c) PO_4^{3-}

Berlin blue prepared from FeCl_3 and $\text{K}_4[\text{Fe}(\text{CN})_6]$. What from agents is necessary for taking much to receive negative sol?

- a) * FeCl_3
- b) In equivalent amounts
- c) $\text{K}_4[\text{Fe}(\text{CN})_6]$

How ferric hydroxides obtained by a method of a hydrolysis will be charged?

- a) *Positively
- b) Negatively

Are the colloidal solutions heterogeneous systems?

- a) *Yes
- b) No

Does viscosity of solutions of protein influences by pH value? (N-viscosity)

- d) *Yes
- e) No

In an isoelectric state the protein have:

- d) *The least degree of a bloating;
- e) The greatest degree of a bloating
- f) pH does not influence a degree of a bloating of protein.

Does the value of zeta - potential influences stability of sols?

- c) *Yes
- d) No

In an isoelectric state of a colloidal micelle:

- d) *Zeta-the potential of a pellet is equal to zero point
- e) Zeta-potential is maximal
- f) Zeta-potential is equal to half of initial value.

What is the ratio between ζ -and zeta- potential?

- a) They are equal;
- b) *The zeta-potential always is only part of a ζ -potential;
- c) The zeta-potential is greater than ζ -potential

What deflocculant is necessary for taking to receive positively charged sol of AgI, obtained on reaction:



- d) KI
- e) K_2SO_4
- f) * $AgNO_3$

Sol have been received with the help of reacting:

$AgNO_3 + KI \Rightarrow AgI$ (settlings) + KNO_3 . That the charge of a pellet was negative, what deflocculant needs to be taken?

- g) * KI
- d) $AgNO_3$
- e) $NaNO_3$
- f) $Al(NO_3)_3$

What there will be by the deflocculant of sol of dioxide of manganese, if $C(KMnO_4) = 2\%$, and $C(\text{natriumthiosulphate}) = 3\%$? The volumes are equal.

- c) Permanganate
- d) *Thiosulphate

Is there the dependence between intensity of scattered light and wave length of a polarized light driving through sol?

- d) *Yes
- e) No

Is the Tyndall-Faradey effect the only optical property of all salts?

- c) Yes
- d) *No

The method of hydrolysis is referred to:

- c) Dispergation methods
- d) *Condensation methods

The synthetic kidney device works by a principle of:

- d) *Compensatory dialysis
- e) Electrodialysis
- f) Ultrafiltration

The degree of dispersion of colloidal solutions is:

- d) * $D \sim 10^{-9} - 10^{-7} \text{ m}^{-1}$
- e) $D \sim 10^{-10} \text{ m}^{-1}$
- f) $D \sim 10^{-6} \text{ m}^{-1} - 10^{-4} \text{ m}^{-1}$

Berlin blue prepared from FeCl_3 and $\text{K}_4[\text{Fe}(\text{CN})_6]$. What from agents is necessary for taking much to receive positive sol?

- a) FeCl_3
- b) In equivalent amounts
- c) * $\text{K}_4[\text{Fe}(\text{CN})_6]$

How the sol will be charged, if it is obtained on dual interchange reaction:

$\text{AgNO}_3 + \text{KI} \Rightarrow \text{AgI} + \text{KNO}_3$, if the deflocculant takes agent AgNO_3 ?

- d) Negatively
- e) *Positively
- f) Neutral

Structure of a micelle of sol of gold: $\{[m \text{ Au} \cdot n \text{ AuO}_2^-](n-x)\text{K}^+\}^x \cdot x\text{K}^+$. What ion will coagulate this sol better?

- d) * Al^{3+}
- e) Na^+
- f) PO_4^{3-}

How ferric hydroxides obtained by a method of a hydrolysis will be charged?

- c) *Positively

d) Negatively

Are the colloidal solutions homogeneous systems?

c) Yes

d) *No

BASIC REFERENCES

1. Medical chemistry: educational and methodical recommendations / A.G. Kaplaushenko, I.A. Iurchenko, B.A. Varinskiy, M.A. Shcherbak, Yu.N. Kucheryavyi. – Zaporozhye, 2014. – 263 p.
2. Medical chemistry: textbook for students of higher medical educational institutions of the III-IV accreditation levels / V.A. Kalibabchuk, V.I. Halynska, V.I., Hryshchenko [et al.]. – Kyiv : Medicine Publishing, 2010. - 223 p.
3. Fundamentals of Medicinal Chemistry / Gareth Thomas, John Wiley & Sons – First Edition. – December, 2003. – 285 p.
4. An Introduction to Medicinal Chemistry / Graham L. Patrick. – Oxford University Press – 4th Edition. – October, 2009. – 776 p.

SUPPORTING REFERENCES

1. Principles of Bioinorganic Chemistry/ Stephen J. Lippard, Jeremy M. Berg, University Science book, 2005, 411 p.
2. Biological Inorganic Chemistry: Structure and Reactivity 1st Edition. Harry B. Gray, Edward I. Stiefel, Joan Selverstone Valentine, Ivano Bertini. University Science book, 2007, 731 p.
3. Biological Inorganic Chemistry, Second Edition: A New Introduction to Molecular Structure and Function 2nd Edition. Robert R. Crichton . Elsevier. 2012, 447 p.
4. Foye's Principles of Medicinal Chemistry 7th Edition. David A. Williams. Lippincott Williams & Wilkins, 2013. 1500 p.
5. Principles of Colloid and Surface Chemistry, Third Edition, Revised and Expanded (Undergraduate Chemistry: A Series of Textbooks) 3rd Edition. Paul C. Hiemenz, Raj Rajagopalan. Taylor & Francis. 1997, 650 p.
6. Physical Chemistry, 9th Edition 9th Edition. Peter Atkins , Julio de Paula. Oxford University Press. 2010. 959 p.
7. Handbook of Surface and Colloid Chemistry, Fourth Edition. K. S. Birdi. CRC Press. 2015. 708 p.